

8R SERIES MINIATURE PUMP

OPERATION & MAINTENANCE MANUAL



Thank you for purchasing this Gast product. It is manufactured to the highest standards using quality materials. Please follow all recommended maintenance, operational and safety instructions and you will receive years of trouble free service.



WARNING



PLEASE READ THIS MANUAL COMPLETELY BEFORE INSTALLING AND USING THIS PRODUCT. SAVE THIS MANUAL FOR FUTURE REFERENCE AND KEEP IN THE VICINITY OF THE PRODUCT.

Product Use Criteria:

- Pump only clean, dry air.
- Operate at 32°F - 104°F (0°C - 40°C).
- Protect unit from dirt & moisture.
- Do not pump flammable or explosive gases or use in an atmosphere that contains such gases.
- Corrosive gases and particulate material will damage unit. Water vapor, oil-based contaminants or other liquids must be filtered out.
- Consult your Gast Distributor/Representative before using at high altitudes.
- This pump is oil-less and requires NO lubrication.
- Units may be used for both pressure and vacuum.



ISO 9001 & 14001 CERTIFIED

www.gastmfg.com

Your safety and the safety of others is extremely important.

We have provided many important safety messages in this manual and on your product. Always read and obey all safety messages.

 This is the safety alert symbol. This symbol alerts you to hazards that can kill or hurt you and others. The safety alert symbol and the words "DANGER" and "WARNING" will precede all safety messages. These words mean:

DANGER

You will be killed or seriously injured if you don't follow instructions.

WARNING

You can be killed or seriously injured if you don't follow instructions.

All safety messages will identify the hazard, tell you how to reduce the chance of injury, and tell you what can happen if the safety instructions are not followed.

INSTALLATION

WARNING

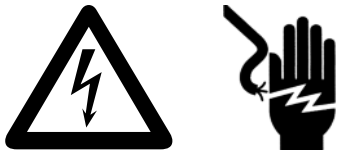

Electrical Shock Hazard

Disconnect electrical power at the circuit breaker or fuse box before installing this product.

Install this product where it will not come into contact with water or other liquids.

Install this product where it will be weather protected.

Electrically ground this product.

Failure to follow these instructions can result in death, fire or electrical shock.

Correct installation is your responsibility. Make sure you have the proper installation conditions and that installation clearances do not block air flow.

Blocking air flow over the product in any way can cause the product to overheat.

Mounting

This product can be installed in any orientation. Mounting the product to a stable, rigid operating surface and using shock mounts will reduce noise and vibration.

Plumbing

To prevent air flow restriction, use pipes and fittings of the same size or larger than the barbed or threaded ports. Note that the ports are not designed to support plumbing.

Accessories

Install gauges in the lines to monitor performance. A relief valve can be installed at the inlet or outlet or both. Consult a Gast representative for performance limitations.

If operating in a dirt contaminated atmosphere, a suitable filter should be used to ensure long service.

Motor Control

It is your responsibility to contact a qualified electrician and assure that the electrical installation is adequate and in conformance with all national and local codes and ordinances.

All electric motors generate heat. To avoid serious burns, never touch unit during or immediately after operation. Always disconnect power source before servicing. Do not block the flow of cooling air over the motor in any way. Keep the air flow vents free of foreign objects, dirt, lint, etc.

Electrical Connection

WARNING

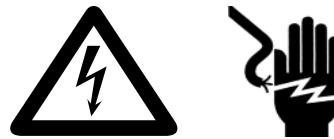

Electrical Shock Hazard

This product must be properly grounded.
Check the condition of the power supply wiring.
Do not permanently connect this product to
wiring that is not in good condition or is
inadequate for the requirements of this product.
Failure to follow these instructions can result in
death, fire or electrical shock.

In the event of an electrical short circuit, grounding reduces the risk of electric shock by providing an escape wire for the electric current. This product may be equipped with a power supply cord having a grounding wire with an appropriate grounding plug. The plug must be plugged into an outlet that is properly installed and grounded in accordance with all local codes and ordinances.

Check with a qualified electrician or serviceman if the grounding instructions are not completely understood, or if you are not sure whether the product is properly grounded. Do not modify the plug provided. If it will not fit the outlet, have the proper outlet installed by a qualified electrician.

Model that is permanently wired:

This product must be connected to a grounded, metallic, permanent wiring system, or an equipment grounding terminal or lead on the product.

Power supply wiring must conform to all required safety codes and be installed by a qualified person. Check that supply voltage agrees with that listed on product nameplate.

Extension cords:

Use only a 3-wire extension cord that has a 3-blade grounding plug. Connect extension cord plug to a matching 3-slot receptacle. Do not use an adapter. Make sure your extension cord is in good condition. Check that the gage wire of the extension cord is the correct size wire to carry the current this product will draw.

Minimum gage for extension cords										
Amps	Volts	Length of cord in feet								
	120v	25	50	100	150	200	250	300	400	500
	240v	50	100	200	300	400	500	600	800	1000
0-2		18	18	18	16	16	14	14	12	12
2-3		18	18	16	14	14	12	12	10	10
3-4		18	18	16	14	12	12	10	10	8
4-5		18	18	14	12	12	10	10	8	8
5-6		18	16	14	12	10	10	8	8	8
6-8		18	16	12	10	10	8	6	6	6
8-10		18	14	12	10	8	8	6	6	4
10-12		16	14	10	8	8	6	6	4	4
12-14		16	12	10	8	6	6	6	4	2
14-16		16	12	10	8	6	6	4	4	2
16-18		14	12	8	8	6	4	4	2	2
18-20		14	12	8	6	6	4	4	2	2

An undersized cord is a potential fire hazard, and will cause a drop in line voltage resulting in loss of power causing the product to overheat. The table indicates the correct size cord for length required and the ampere rating listed on the product nameplate. **If in doubt, use the next heavier gage cord. The smaller the gage number, the heavier the wire gage.**

OPERATION

! WARNING

Injury Hazard

Use only recommended air handling parts acceptable for pressure not less than 70 psi.
 Keep fingers and objects away from openings and rotating parts.
 Product surfaces become hot during operation, allow product surfaces to cool before handling.
 Do NOT direct air stream at body. Air stream from product may contain solid or liquid material that can result in eye or skin damage, wear proper eye protection.
 Do NOT spray flammable or combustible liquid.
 Failure to follow these instructions can result in burns, eye injury or other serious injury.

It is your responsibility to operate this product at recommended pressures or vacuum duties and room ambient temperatures. Do not start against a vacuum or pressure load.

Start Up

If motor fails to start or slows down significantly under load, shut off and disconnect from power supply. Check that the voltage is correct for motor.

MAINTENANCE

! WARNING

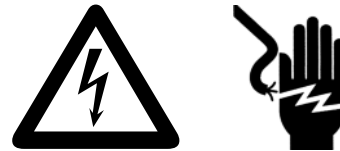

Electrical Shock Hazard

Disconnect electrical power supply cord before performing maintenance on this product.

If product is hard wired into system, disconnect electrical power at the circuit breaker or fuse box before performing maintenance on this product.

Failure to follow these instructions can result in death, fire or electrical shock.

! WARNING

Injury Hazard

Product surfaces become very hot during operation, allow product surfaces to cool before handling.

Air stream from product may contain solid or liquid material that can result in eye or skin damage, wear proper eye protection.

Clean this product in a well ventilated area.

Failure to follow these instructions can result in burns, eye injury or other serious injury.

It is your responsibility to:

- Regularly inspect and make necessary repairs to product in order to maintain proper operation.
- Make sure that pressure and vacuum are released from product before starting maintenance.

SHUTDOWN PROCEDURES

It is your responsibility to follow proper shutdown procedures to prevent product damage. NEVER ADD OIL TO THIS OIL-LESS PUMP.

Proper shutdown procedures must be followed to prevent pump damage. Failure to do so may result in premature pump failure. Follow all the steps to assure correct storage and shutdown between operating periods.

1. Disconnect plumbing.
2. Operate product for at least 5 minutes without plumbing.
3. Run at maximum vacuum for 10 to 15 minutes.
4. Repeat step 2.
5. Disconnect power supply.
6. Plug open ports to prevent dirt or other contaminants from entering product.

SERVICE KIT INSTALLATION

WARNING

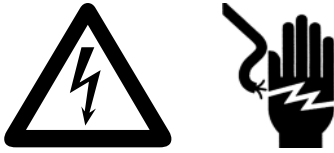

Electrical Shock Hazard

Disconnect electrical power supply cord before installing Service Kit.

If product is hard wired into system, disconnect electrical power at the circuit breaker or fuse box before installing Service Kit.

Disconnect air supply and vent all air lines to release pressure or vacuum.

Failure to follow these instructions can result in death, fire or electrical shock.

Gast will NOT guarantee field-rebuilt product performance. For performance guarantee, the product must be returned to a Gast Authorized Service Facility.

Disassembly

To make reassembly easier, note the location of parts when disassembling.

1. Disconnect electrical power to pump.
2. Disconnect air supply and vent all air lines to release pressure or vacuum.
3. Note the direction of the arrows so you can orient the pump head correctly during reinstallation.
4. Remove the four corner head screws and remove the head and valve.
5. Clean the pump using water-based solvents.

WARNING



Solvent Stream

May contain solid or liquid material that can result in eye or skin damage.

Wear eye protection when using this product.

Solvent Cleaning

Use only Gast AH255B Solvent or other non-petroleum based solvent. Do Not use kerosene or ANY other combustible solvent to clean product.

Reassembly

1. Place the valve in the valve plate pocket using the notch in both parts as an aid in orientation.
 2. Assemble the head by aligning the two holes with the two pins in the valve plate.
 3. Torque the head screws to 6 in. lbs. into the bracket.
- CAUTION:

Do not over-tighten head screw(s). To do so can risk stripping the plastic threads.

If pump still does not produce proper vacuum or pressure, send unit to a Gast Authorized Service Facility for repair.

DC WIRING

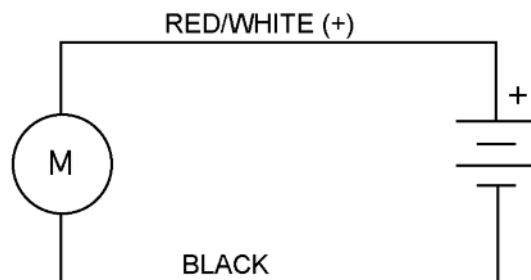

AC WIRING

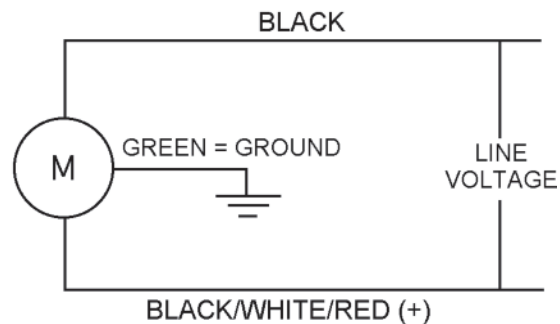

TROUBLESHOOTING GUIDE

SYMPTOM	POSSIBLE CAUSE	POINT TO CHECK
Won't Start	<ul style="list-style-type: none"> • Electrical connection • Dirty muffler • Wrong/Low voltage • Pressure/Vacuum on head • Thermal overload tripped 	<ul style="list-style-type: none"> • Ensure electrical power is supplied • Is muffler clogged • Inspect power supply • Inspect relief valve • Inspect above points
Excessive Noise	<ul style="list-style-type: none"> • Wrong voltage • Hose or plumbing leak • Checkvalve leaks 	<ul style="list-style-type: none"> • Inspect power supply • Inspect hoses for cracks • Inspect check valve
Overheating	<ul style="list-style-type: none"> • Dirty filter • Dirty muffler • Low voltage • Dirty valves 	<ul style="list-style-type: none"> • Inspect filter • Is muffler clogged • Inspect power supply • Remove head and inspect valve
Low Pressure/ Vacuum	<ul style="list-style-type: none"> • Dirty filter • Dirty muffler • Low voltage • Wrong AC voltage frequency • Damaged/contaminated diaphragm 	<ul style="list-style-type: none"> • Inspect filter • Inspect muffler • Inspect power supply • Inspect power supply • Remove head & valve plate; inspect diaphragm

WARRANTY

Gast finished products, when properly installed and operated under normal conditions of use, are warranted by Gast to be free from defects in material and workmanship for a period of twelve (12) months from the date of purchase from Gast or an authorized Gast Representative or Distributor. In order to obtain performance under this warranty, the buyer must promptly (in no event later than thirty (30) days after discovery of the defect) give written notice of the defect to Gast Manufacturing Incorporated, PO Box 97, Benton Harbor Michigan USA 49023-0097 or an authorized Service Center (unless specifically agreed upon in writing signed by both parties or specified in writing as part of a Gast OEM Quotation). Buyer is responsible for freight charges both to and from Gast in all cases.

This warranty does not apply to electric motors, electrical controls, and gasoline engines not supplied by Gast. Gast's warranties also do not extend to any goods or parts which have been subjected to misuse, lack of maintenance, neglect, damage by accident or transit damage.

THIS EXPRESS WARRANTY EXCLUDES ALL OTHER WARRANTIES OR REPRESENTATIONS EXPRESSED OR IMPLIED BY ANY LITERATURE, DATA, OR PERSON. GAST'S MAXIMUM LIABILITY UNDER THIS EXCLUSIVE REMEDY SHALL NEVER EXCEED THE COST OF THE SUBJECT PRODUCT AND GAST RESERVES THE RIGHT, AT ITS SOLE DISCRETION, TO REFUND THE PURCHASE PRICE IN LIEU OF REPAIR OR REPLACEMENT.

GAST WILL NOT BE RESPONSIBLE OR LIABLE FOR INDIRECT OR CONSEQUENTIAL DAMAGES OF ANY KIND, however arising, including but not limited to those for use of any products, loss of time, inconvenience, lost profit, labor charges, or other incidental or consequential damages with respect to persons, business, or property, whether as a result of breach of warranty, negligence or otherwise. Notwithstanding any other provision of this warranty, BUYER'S REMEDY AGAINST GAST FOR GOODS SUPPLIED OR FOR NON-DELIVERED GOODS OR FAILURE TO FURNISH GOODS, WHETHER OR NOT BASED ON NEGLIGENCE, STRICT LIABILITY OR BREACH OF EXPRESS OR IMPLIED WARRANTY IS LIMITED SOLELY, AT GAST'S OPTION, TO REPLACEMENT OF OR CURE OF SUCH NON-CONFORMING OR NON-DELIVERED GOODS OR RETURN OF THE PURCHASE PRICE FOR SUCH GOODS AND IN NO EVENT SHALL EXCEED THE PRICE OR CHARGE FOR SUCH GOODS. GAST EXPRESSLY DISCLAIMS ANY WARRANTY OF MERCHANTABILITY OR FITNESS FOR A PARTICULAR USE OR PURPOSE WITH RESPECT TO THE GOODS SOLD. THERE ARE NO WARRANTIES WHICH EXTEND BEYOND THE DESCRIPTIONS SET FORTH IN THIS WARRANTY, notwithstanding any knowledge of Gast regarding the use or uses intended to be made of goods, proposed changes or additions to goods, or any assistance or suggestions that may have been made by Gast personnel.

Unauthorized extensions of warranties by the customer shall remain the customer's responsibility.

CUSTOMER IS RESPONSIBLE FOR DETERMINING THE SUITABILITY OF GAST PRODUCTS FOR CUSTOMER'S USE OR RESALE, OR FOR INCORPORATING THEM INTO OBJECTS OR APPLICATIONS WHICH CUSTOMER DESIGNS, ASSEMBLES, CONSTRUCTS OR MANUFACTURES.

This warranty can be modified only by authorized Gast personnel by signing a specific, written description of any modifications.

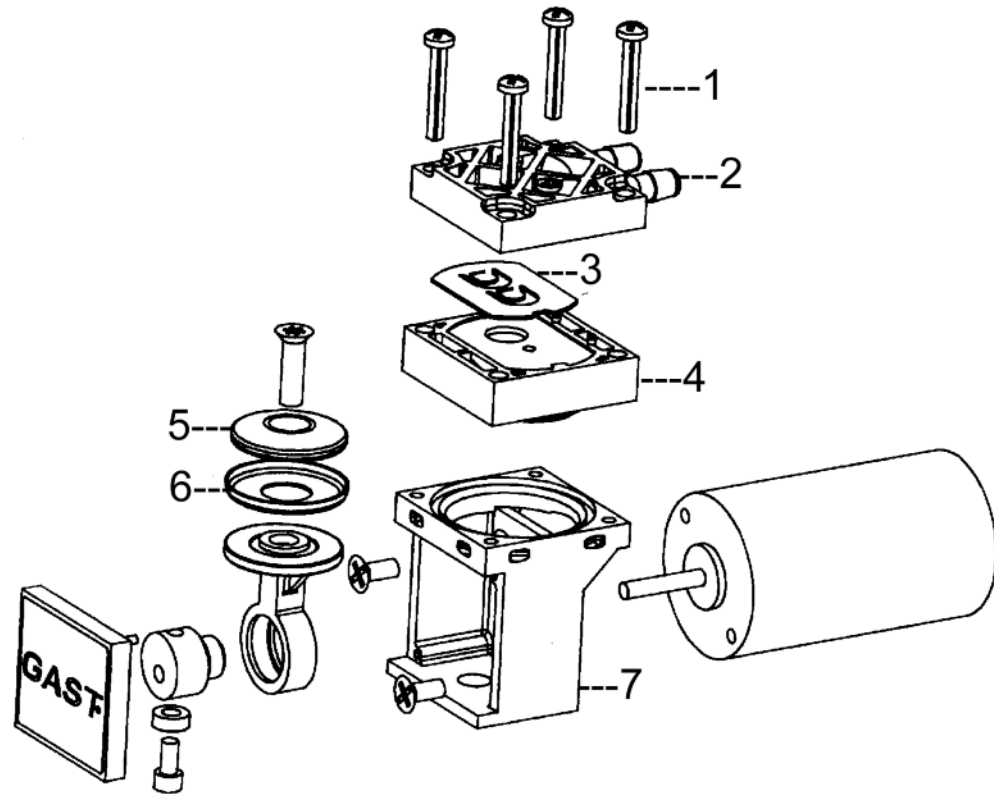

PARTS & ORDERING INFORMATION

Ref No.	Description	Quantity	8R Neoprene Valve & Similar Models	8R EPDM Valve & Similar Models
1	Head screws	4	SCR1014	SCR1014
2	Head	1	HDC1005	HDC1005
3	*Valve	1	VLV1004 (Neoprene)	VLV1005 (EPDM)
4	Valve plate	1	VPL1006	VPL1006
5	Retrainer	1	RPL1006	RPL1006
6	Cup	1	CUP1001	CUP1001
7	Bracket	1	BKT1007A	BKT1007A
	Service Kit	1	No kit	K643 (EPDM)
	Each service kit contains 1 valve			
	*Denotes part in Service Kit			

Parts listed are for stock models. For specific OEM models, please consult the factory.

When corresponding or ordering parts, please give complete model and serial numbers.

World Headquarters

P.O. Box 97
 2550 Meadowbrook Rd.
 Benton Harbor, MI 49023-0097
 Ph: 269/926-6171
 FAX: 269/925-8288
 www.gastmfg.com

Gast Hong Kong

Unit 12, 21/F, Block B
 New Trade Plaza
 6, On Ping Street, Shatin
 N. T. Hong Kong
 Ph: (852) 2690 1008
 Fax: (852) 26901012
 www.gastmfg.com

For the name of the nearest authorized service facility, contact one of our offices or visit our website at www.gastmfg.com.



A Unit of **INX** Corporation

ISO 9001 & 14001 CERTIFIED

www.gastmfg.com

